

O'REILLY®

Compliments of
NGINX

Docker Networking and Service Discovery



Michael Hausenblas

NGINX

Containers without chaos

Flawless application delivery with NGINX Plus



Advanced load balancing and automated routing



On-the-fly reconfiguration for scalable service discovery



Application-aware health checks and container monitoring



Content caching for better availability and performance



Access controls and rate limiting to secure your applications

Learn more at:
nginx.com/microservices

Docker Networking and Service Discovery

Michael Hausenblas

Beijing • Boston • Farnham • Sebastopol • Tokyo

O'REILLY®

Docker Networking and Service Discovery

by Michael Hausenblas

Copyright © 2016 O'Reilly Media, Inc. All rights reserved.

Printed in the United States of America.

Published by O'Reilly Media, Inc., 1005 Gravenstein Highway North, Sebastopol, CA 95472.

O'Reilly books may be purchased for educational, business, or sales promotional use. Online editions are also available for most titles (<http://safaribooksonline.com>). For more information, contact our corporate/institutional sales department: 800-998-9938 or corporate@oreilly.com.

Editor: Brian Anderson

Production Editor: Kristen Brown

Copyeditor: Jasmine Kwitny

Interior Designer: David Futato

Cover Designer: Karen Montgomery

Illustrator: Rebecca Demarest

February 2016: First Edition

Revision History for the First Edition

2016-01-11: First Release

The O'Reilly logo is a registered trademark of O'Reilly Media, Inc. *Docker Networking and Service Discovery*, the cover image, and related trade dress are trademarks of O'Reilly Media, Inc.

While the publisher and the author have used good faith efforts to ensure that the information and instructions contained in this work are accurate, the publisher and the author disclaim all responsibility for errors or omissions, including without limitation responsibility for damages resulting from the use of or reliance on this work. Use of the information and instructions contained in this work is at your own risk. If any code samples or other technology this work contains or describes is subject to open source licenses or the intellectual property rights of others, it is your responsibility to ensure that your use thereof complies with such licenses and/or rights.

978-1-491-95095-1

[LSI]

Table of Contents

Foreword.....	v
Preface.....	vii
1. Motivation.....	1
Go Cattle!	2
Docker Networking and Service Discovery Stack	3
Do I Need to Go “All In”?	4
2. Docker Networking 101.....	7
Bridge Mode Networking	9
Host Mode Networking	10
Container Mode Networking	11
No Networking	12
Wrapping It Up	13
3. Docker Multihost Networking.....	15
Overlay	16
Flannel	16
Weave	16
Project Calico	17
Open vSwitch	17
Pipework	17
OpenVPN	17
Future Docker Networking	18

Wrapping It Up	18
4. Containers and Service Discovery	21
The Challenge	21
Technologies	23
Load Balancing	29
Wrapping It Up	30
5. Containers and Orchestration	33
What Does a Scheduler Actually Do?	35
Vanilla Docker and Docker Swarm	36
Kubernetes	38
Apache Mesos	41
Hashicorp Nomad	44
Which One Should I Use?	45
A. References	51

Foreword

Like many others, I've been impressed with how much easier Docker makes application development. Every component I need is already containerized and available on Docker Hub. All that's left for me to do is stitch them together and add in my application logic. Docker abstracts away most of the details of the environment, so the application I've built on my laptop will run in exactly the same way on a production server. In other words, with Docker I can just focus on writing code.

Though Docker-based applications run the same in all environments, being in production introduces a whole host of challenges that don't apply in development environments. Whereas during development my app ran in a sandbox on my laptop, in production I now have to worry about connectivity, scaling to handle load, being secure against malicious users, and sharing resources with potentially hundreds of other apps (or microservices) running within the same environment.

Author Michael Hausenblas addresses these challenges of networking and service discovery with great advice and practical guidance. As you'll see throughout this report, open source NGINX and our commercial-grade application delivery platform, NGINX Plus, can be key components in successful production deployments with Docker.

On the frontend, NGINX Plus acts as a stable entrypoint to your Docker application, a persistent and reliable place for clients to connect. This solves one challenge of containers—they're ephemeral by design, and clients can't connect to something that might disappear at any moment. In addition, NGINX Plus routes and load balances traffic across your containers, integrates nicely with service discovery platforms, and can be reconfigured automatically when the set of service instances changes.

As you move to a containerized infrastructure, we'd be thrilled to show you how to optimize it with NGINX Plus. We sincerely hope you enjoy this report, and that it helps you succeed with your first production deployments of containers.

—Faisal Memon, Product Marketer, NGINX, Inc.

Preface

When you start building your applications with Docker, you're excited about the capabilities and opportunities you encounter: it runs the same in dev and in prod, it's straightforward to put together a Docker image, and the distribution is taken care of by tools like the Docker hub. So, you're satisfied with how quickly you were able to port an existing, say, Python app, to Docker and you want to connect it to another container that has a database, such as PostgreSQL. Also, you don't want to manually launch the Docker containers and implement your own system that takes care of checking if the containers are still running, and if not, relaunch them.

At this juncture, you realize there are two related challenges you've been running into: networking and service discovery. Unfortunately, these two areas are emerging topics, which is a fancy way of saying there are still a lot of moving parts, and there are currently few best practice resources available in a central place. Fortunately, there are tons of recipes available, even if they are scattered over a gazillion blog posts and many articles.

The Book

So, I thought to myself: what if someone wrote a book providing some basic guidance for these topics, pointing readers in the right direction for each of the technologies?

That *someone* turned out to be me, and with this book I want to provide you—in the context of Docker containers—with an overview of the challenges and available solutions for networking as well as ser-

vice discovery. I will try to drive home three points throughout this book:

- Service discovery and container orchestration are two sides of the same coin.
- Without a proper understanding of the networking aspect of Docker and a sound strategy in place, you will have more than one bad day.
- The space of networking and service discovery is young: you will find yourself starting out with one set of technologies and likely change gears and try something else; do not worry, you're in good company and in my opinion it will take another two odd years until standards emerge and the market is consolidated.

Orchestration and Scheduling

Strictly speaking, orchestration is a more general process than scheduling: it subsumes scheduling but also covers other things, such as relaunching a container on failure (either because the container itself became unhealthy or its host is in trouble). So, while scheduling really is only the process of deciding which container to put on which host, I use these two terms interchangeably in the book.

I do this because, first, because there's no official definition (as in: an IETF RFC or a NIST standard), and second, because the marketing of different companies sometimes deliberately mix them up, so I want you to prepare for this. However, Joe Beda (former Googler and Kubernetes mastermind), put together a rather nice article on this topic, should you wish to dive deeper: [“What Makes a Container Cluster?”](#)

You

My hope is that the book is useful for:

- Developers who drank the Docker Kool-Aid
- Network ops who want to brace themselves for the upcoming onslaught of their enthusiastic developers

- (Enterprise) software architects who are in the process of migrating existing workloads to Docker or starting a new project with Docker
- Last but not least, I suppose that distributed application developers, SREs, and backend engineers can also extract some value out of it.

Note that this is not a hands-on book—besides the basic Docker networking stuff in [Chapter 2](#)—but more like a guide. You will want to use it to make an informed decision when planning Docker-based deployments. Another way to view the book is as a heavily annotated bookmark collection.

Me

I work for a cool startup called Mesosphere, Inc. (the commercial entity behind Apache Mesos), where I help devops to get the most out of the software. While I'm certainly biased concerning Mesos being the best current option to do cluster scheduling at scale, I will do my best to make sure throughout the book that this preference does not negatively influence the technologies discussed in each section.

Acknowledgments

Kudos to my Mesosphere colleagues from the Kubernetes team: James DeFelice and Stefan Schimanski have been very patient answering my questions around Kubernetes networking. Another round of kudos go out to my Mesosphere colleagues (and former Docker folks) Sebastien Pahl and Tim Fall—I appreciate all of your advice around Docker networking very much! And thank you as well to Mohit Soni, yet another Mesosphere colleague who took time out of his busy schedule to provide feedback!

I further would like to thank Medallia's Thorvald Natvig, whose [Velocity NYC 2015](#) talk triggered me to think deeper about certain networking aspects; he was also kind enough to allow me to follow up with him and discuss motivations of and lessons learned from Medallia's Docker/Mesos/Aurora prod setup.

Thank you very much, Adrian Mouat (Container Solutions) and Diogo Mónica (Docker, Inc.), for answering questions via Twitter,

and especially for the speedy replies during hours where normal people sleep, geez!

I'm grateful for the feedback I received from Chris Swan, who provided clear and actionable comments throughout, and by addressing his concerns, I believe the book became more objective as well.

Throughout the book writing process, Mandy Waite (Google) provided incredibly useful feedback, particularly concerning Kubernetes; I'm so thankful for this and it certainly helped to make things clearer. I'm also grateful for the support I got from Tim Hockin (Google), who helped me clarify the confusion around the new Docker networking features and Kubernetes.

Thanks to Matthias Bauer, who read an early draft of this manuscript and provided great comments I was able to build on.

A big thank you to my O'Reilly editor Brian Anderson. From the first moment we discussed the idea to the drafts and reviews, you've been very supportive, extremely efficient (and fun!), and it's been a great pleasure to work with you.

Last but certainly not least, my deepest gratitude to my awesome family: our "sunshine" Saphira, our "sporty girl" Ranya, our son and "*Minecraft* master" Iannis, and my ever-supportive wife Anneliese. Couldn't have done this without you and the cottage is my second-favorite place when I'm at home. ;)

Motivation

In February 2012, Randy Bias gave an impactful talk on **architectures for open and scalable clouds**. In his presentation, he established the *pets versus cattle meme*:¹

- With the *pets approach to infrastructure*, you treat the machines as individuals. You give each (virtual) machine a name and applications are statically allocated to machines. For example, db-prod-2 is one of the production servers for a database. The apps are manually deployed and when a machine gets ill you nurse it back to health and again manually redeploy the app it ran onto another machine. This approach is generally considered to be the dominant paradigm of a previous (non-cloud-native) era.
- With the *cattle approach to infrastructure*, your machines are anonymous, they are all identical (modulo hardware upgrades), have numbers rather than names, and apps are automatically deployed onto any and each of the machines. When one of the machines gets ill, you don't worry about it immediately, and replace it (or parts of it, such as a faulty HDD) when you want and not when things break.

While the original meme was focused on virtual machines, we apply the cattle approach to infrastructure to containers.

¹ In all fairness, Randy did attribute the origins to Bill Baker of Microsoft.

Go Cattle!

The beautiful thing about applying the cattle approach to infrastructure is that it allows you to scale out on commodity hardware.²

It gives you elasticity with the implication of hybrid cloud capabilities. This is a fancy way of saying that you can have a part of your deployments on premises and burst into the public cloud (as well as between IaaS offerings of different providers) if and when you need it.

Most importantly, from an operator's point of view, the cattle approach allows you to get a decent night's sleep, as you're no longer paged at 3 a.m. just to replace a broken HDD or to relaunch a hanging app on a different server, as you would have done with your pets.

However, the cattle approach poses some challenges that generally fall into one of the following two categories:

Social challenges

I dare say most of the challenges are of a social nature: *How do I convince my manager? How do I get buy-in from my CTO? Will my colleagues oppose this new way of doing things? Does this mean we will need less people to manage our infrastructure?* Now, I will not pretend to offer ready-made solutions for this part; instead, go buy a copy of *The Phoenix Project*, which should help you find answers.

Technical challenges

In this category, you will find things like selection of base provisioning mechanism of the machines (e.g., using Ansible to deploy Mesos Agents), how to set up the communication links between the containers and to the outside world, and most importantly, how to ensure the containers are automatically deployed and are consequently findable.

² Typically even very homogenous hardware—see, for example, slide 7 of the PDF slide deck for Thorvald Natvig's Velocity NYC 2015 talk "[Challenging Fundamental Assumptions of Datacenters: Decoupling Infrastructure from Hardware](#)".

Docker Networking and Service Discovery Stack

The overall stack we're dealing with here is depicted in [Figure 1-1](#) and is comprised of the following:

The low-level networking layer

This includes networking gear, iptables, routing, IPVLAN, and Linux namespaces. You usually don't need to know the details here, unless you're on the networking team, but you should be aware of it. See [Chapter 2](#) for more information on this topic.

A Docker networking layer

This encapsulates the low-level networking layer and provides some abstractions such as the single-host bridge networking mode or a multihost, IP-per-container solution. I cover this layer in [Chapters 2 and 3](#).

A service discovery/container orchestration layer

Here, we're marrying the container scheduler decisions on where to place a container with the primitives provided by lower layers. [Chapter 4](#) provides you with all the necessary background on service discovery, and in [Chapter 5](#), we look at networking and service discovery from the point of view of the container orchestration systems.

Software-Defined Networking (SDN)

SDN is really an umbrella (marketing) term, providing essentially the same advantages to networks that VMs introduced over bare-metal servers. The network administration team becomes more agile and can react faster to changing business requirements. Another way to view it is: SDN is the configuration of networks using software, whether that is via APIs, complementing NFV, or the construction of networks from software; the [Docker networking](#) provides for SDN.

Especially if you're a developer or an architect, I suggest taking a quick look at [Cisco's nice overview](#) on this topic as well as SDxCentral's article "[What's Software-Defined Networking \(SDN\)?](#)"

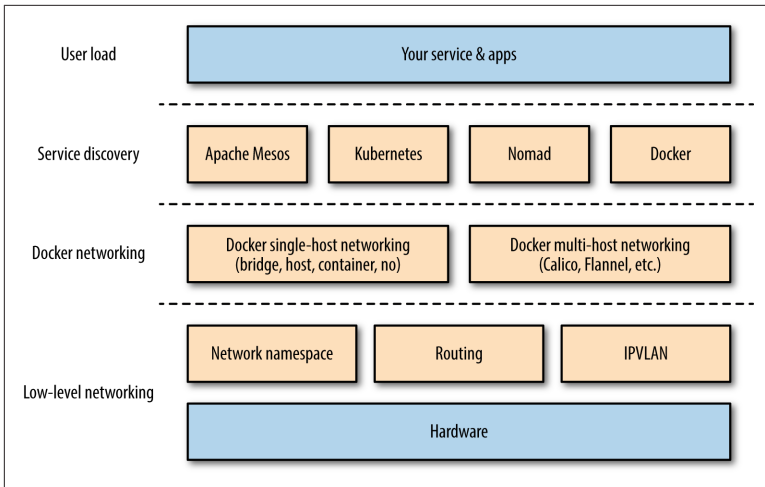

Figure 1-1. Docker networking and service discovery (DNSSD) stack

If you are on the network operations team, you're probably good to go for the next chapter. However, if you're an architect or developer and your networking knowledge might be a bit rusty, I suggest brushing up your knowledge by studying the [Linux Network Administrators Guide](#) before advancing.

Do I Need to Go “All In”?

Oftentimes when I'm at conferences or user groups, I meet people who are very excited about the opportunities in the container space but at the same time they (rightfully) worry about how deep they need to commit in order to benefit from it. The following table provides an informal overview of deployments I have seen in the wild, grouped by level of commitment (stages):

Stage	Typical Setup	Examples
Traditional	Bare-metal or VM, no containers	Majority of today's prod deployments
Simple	Manually launched containers used for app-level dependency management	Development and test environments
Ad hoc	A custom, homegrown scheduler to launch and potentially restart containers	RelateIQ , Uber

Stage	Typical Setup	Examples
Full-blown	An established scheduler from Chapter 5 to manage containers; fault tolerant, self-healing	Google, Zulily, Gutexfrage.de

Note that not all of these examples use Docker containers (notably, Google does not) and that some start out, for instance, in the ad-hoc stage and are transitioning to a full-blown stage as we speak (Uber is such a case; see [this presentation](#) from ContainerSched 2015 in London). Last but not least, the stage doesn't necessarily correspond with the size of the deployment. For example, Gutexfrage.de only has [six bare-metal servers](#) under management, yet uses Apache Mesos to manage them.

One last remark before we move on: by now, you might have already realized that we are dealing with distributed systems in general here. Given that we will usually want to deploy containers into a network of computers (i.e., a cluster), I strongly suggest reading up on the [fallacies of distributed computing](#), in case you are not already familiar with this topic.

And now, without further ado, let's jump into the deep end with Docker networking.

Docker Networking 101

Before we get into the networking side of things, let's have a look at what is going on in the case of a single host. A Docker container needs a host to run on. This can either be a physical machine (e.g., a bare-metal server in your on-premise datacenter) or a VM either on-prem or in the cloud. The host has the Docker daemon and client running, as depicted in [Figure 2-1](#), which enables you to interact with a **Docker registry** on the one hand (to pull/push Docker images), and on the other hand, allows you to start, stop, and inspect containers.

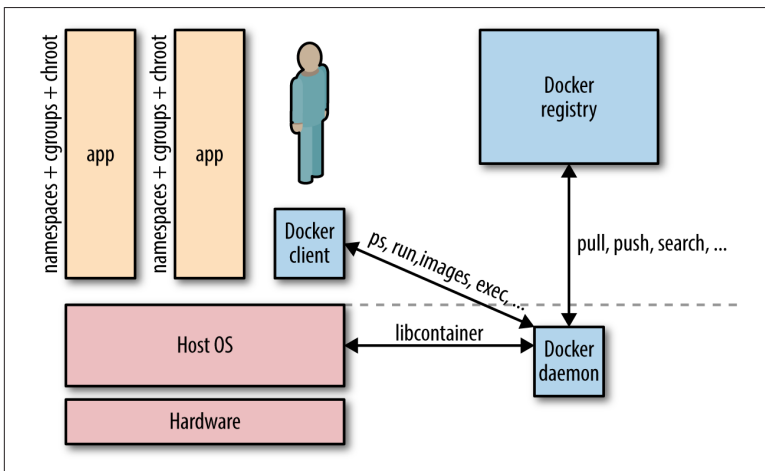

Figure 2-1. Simplified Docker architecture (single host)

The relationship between a host and containers is 1: N . This means that one host typically has several containers running on it. For example, **Facebook** reports that—depending on how beefy the machine is—it sees on average some 10 to 40 containers per host running. And here’s another data point: at Mesosphere, we found in various load tests on bare metal that not more than around 250 containers per host would be possible.¹

No matter if you have a single-host deployment or use a cluster of machines, you will almost always have to deal with networking:

- For most *single-host deployments*, the question boils down to data exchange via a **shared volume** versus data exchange through networking (HTTP-based or otherwise). Although a Docker data volume is simple to use, it also introduces tight coupling, meaning that it will be harder to turn a single-host deployment into a multihost deployment. Naturally, the upside of shared volumes is speed.
- In *multihost deployments*, you need to consider two aspects: how are containers communicating within a host and how does the communication paths look between different hosts. Both performance considerations and security aspects will likely influence your design decisions. Multihost deployments usually become necessary either when the capacity of a single host is insufficient (see the earlier discussion on average and maximal number of containers on a host) or when one wants to employ distributed systems such as Apache Spark, HDFS, or Cassandra.

Distributed Systems and Data Locality

The basic idea behind using a distributed system (for computation or storage) is to benefit from parallel processing, usually together with data locality. By data locality I mean the principle to ship the code to where the data is rather than the (traditional) other way around. Think about the following for a moment: if your dataset size is in the TB and your code size is in the MB, it’s more efficient to move the code across the cluster than transferring TBs of data to a central processing place. In addition to being able to process things in parallel, you usually gain fault tolerance with distributed

¹ This might have been a potential limitation of the Docker daemon at that time.

systems, as parts of the system can continue to work more or less independently.

This chapter focuses on networking topics for the single-host case, and in [Chapter 3](#), we will discuss the multihost scenarios.

Simply put, Docker networking is the native container SDN solution you have at your disposal when working with Docker. In a nutshell, there are four modes available for Docker networking: bridge mode, host mode, container mode, or no networking.² We will have a closer look at each of those modes relevant for a single-host setup and conclude at the end of this chapter with some general topics such as security.

Bridge Mode Networking

In this mode (see [Figure 2-2](#)), the Docker daemon creates `docker0`, a virtual Ethernet bridge that automatically forwards packets between any other network interfaces that are attached to it. By default, the daemon then connects all containers on a host to this internal network through creating a pair of peer interfaces, assigning one of the peers to become the container's `eth0` interface and other peer in the namespace of the host, as well as assigning an IP address/subnet from the [private IP range](#) to the bridge ([Example 2-1](#)).

Example 2-1. Docker bridge mode networking in action

```
$ docker run -d -P --net=bridge nginx:1.9.1
$ docker ps
CONTAINER ID   IMAGE          COMMAND          CREATED
STATUS        PORTS         NAMES
17d447b7425d  nginx:1.9.1   nginx -g        19 seconds ago
Up 18 seconds  0.0.0.0:49153->443/tcp,
               0.0.0.0:49154->80/tcp  trusting_feynman
```

² Note that with Docker 1.9, the [networking documentation](#) doesn't mention the container mode anymore, while it's still supported and listed in the [run reference](#).

NOTE

Because bridge mode is the Docker default, you could have equally used `docker run -d -P nginx:1.9.1` in [Example 2-1](#). If you do not use `-P` (which publishes all exposed ports of the container) or `-p host_port:container_port` (which publishes a specific port), the IP packets will not be routable to the container outside of the host.

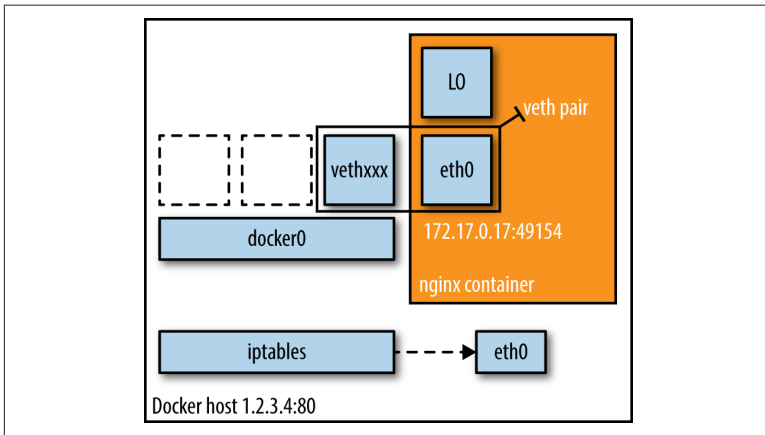

Figure 2-2. Bridge mode networking setup

TIP

In production, I suggest using the Docker host mode (discussed in [“Host Mode Networking”](#) on page 10) along with one of the SDN solutions from [Chapter 3](#). Further, to influence the network communication between containers, you can use the `flags --iptables` and `-icc`.

Host Mode Networking

This mode effectively disables network isolation of a Docker container. Because the container shares the networking namespace of the host, it is directly exposed to the public network; consequently, you need to carry out the coordination via port mapping.

Example 2-2. Docker host mode networking in action

```
$ docker run -d --net=host ubuntu:14.04 tail -f /dev/null
$ ip addr | grep -A 2 eth0:
2: eth0: <BROADCAST,MULTICAST,UP,LOWER_UP> mtu 9001 qdisc mq state
```

```

UP group default qlen 1000
    link/ether 06:58:2b:07:d5:f3 brd ff:ff:ff:ff:ff:ff
    inet **10.0.7.197**/22 brd 10.0.7.255 scope global dynamic eth0

$ docker ps
CONTAINER ID   IMAGE     COMMAND   CREATED
STATUS        PORTS    NAMES
b44d7d5d3903  ubuntu:14.04  tail -f  2 seconds ago
Up 2 seconds          jovial_blackwell
$ docker exec -it b44d7d5d3903 ip addr
2: eth0: <BROADCAST,MULTICAST,UP,LOWER_UP> mtu 9001 qdisc mq state
UP group default qlen 1000
    link/ether 06:58:2b:07:d5:f3 brd ff:ff:ff:ff:ff:ff
    inet **10.0.7.197**/22 brd 10.0.7.255 scope global dynamic eth0

```

And there we have it: as shown in [Example 2-2](#), the container has the same IP address as the host, namely 10.0.7.197.

In [Figure 2-3](#), we see that when using host mode networking, the container effectively inherits the IP address from its host. This mode is faster than the bridge mode (because there is no routing overhead), but it exposes the container directly to the public network, with all its security implications.

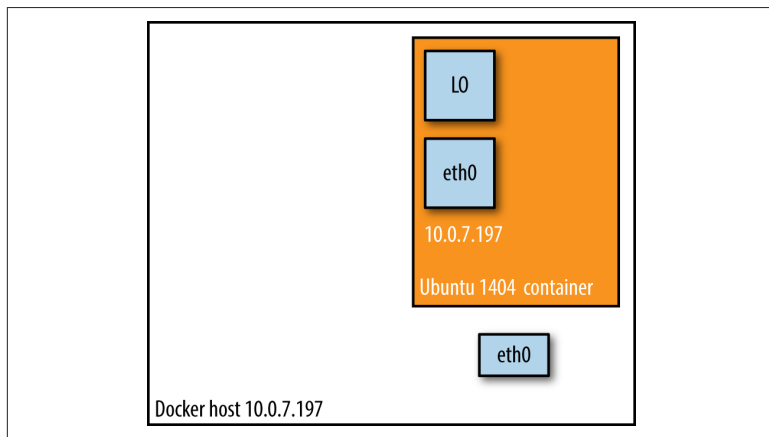

Figure 2-3. Docker host mode networking setup

Container Mode Networking

In this mode, you tell Docker to reuse the networking namespace of another container. In general, this mode is useful when you want to provide custom network stacks. Indeed, this mode is also what

Kubernetes networking leverages and you can read more on this topic in “Kubernetes” on page 38.

Example 2-3. Docker container mode networking in action

```
$ docker run -d -P --net=bridge nginx:1.9.1
$ docker ps
CONTAINER ID   IMAGE          COMMAND         CREATED        STATUS
PORTS         NAMES
eb19088be8a0  nginx:1.9.1   nginx -g       3 minutes ago  Up 3 minutes
0.0.0.0:32769->80/tcp,
0.0.0.0:32768->443/tcp   admiring_engelbart
$ docker exec -it admiring_engelbart ip addr
8: eth0@if9: <BROADCAST,MULTICAST,UP,LOWER_UP> mtu 9001 qdisc
noqueue state UP group default
    link/ether 02:42:ac:11:00:03 brd ff:ff:ff:ff:ff:ff
    inet **172.17.0.3**/16 scope global eth0

$ docker run -it --net=container:admiring_engelbart ubuntu:14.04
ip addr
...
8: eth0@if9: <BROADCAST,MULTICAST,UP,LOWER_UP> mtu 9001 qdisc
noqueue state UP group default
    link/ether 02:42:ac:11:00:03 brd ff:ff:ff:ff:ff:ff
    inet **172.17.0.3**/16 scope global eth0
```

The result (as shown in [Example 2-3](#)) is what we would have expected: the second container, started with `--net=container`, has the same IP address as the first container with the glorious auto-assigned name `admiring_engelbart`, namely `172.17.0.3`.

No Networking

This mode puts the container inside of its own network stack but doesn't configure it. Effectively, this turns off networking and is useful for two cases: either for containers that don't need a network (such as batch jobs writing to a disk volume) or if you want to set up your custom networking—see [Chapter 3](#) for a number of options that leverage this.

Example 2-4. Docker no-networking in action

```
$ docker run -d -P --net=None nginx:1.9.1
$ docker ps
CONTAINER ID   IMAGE          COMMAND         CREATED
STATUS        PORTS         NAMES
```



```
d8c26d68037c  nginx:1.9.1    nginx -g 2 minutes ago
Up 2 minutes          grave_perlman
$ docker inspect d8c26d68037c | grep IPAddress
  "IPAddress": "",
  "SecondaryIPAddresses": null,
```

And as you can see in [Example 2-4](#), there is no network configured—precisely as we would have hoped for.

You can read more about networking and learn about configuration options on the excellent [Docker docs pages](#).

NOTE

All Docker commands in this book have been executed in a CoreOS environment with both Docker client and server on version 1.7.1.

Wrapping It Up

In this chapter, we had a look at the four basic Docker single-host networking modes. We will now briefly discuss other aspects you should be aware of (and which are equally relevant for multihost deployments):

Allocating IP addresses

Manually allocating IP addresses when containers come and go frequently and in large numbers is not sustainable.³ The bridge mode takes care of this issue to a certain extent. To prevent ARP collisions on a local network, the Docker daemon generates a random MAC address from the allocated IP address. We will revisit this allocation challenge in the next chapter.

Allocating ports

You will find yourself either in the fixed-port-allocation or in the dynamically-port-allocation camp. This can be per service/application or as a global strategy, but you must make up your mind. Remember that, for bridge mode, Docker can automatically assign (UDP or TCP) ports and consequently make them routable.

³ New Relic, for example, found the majority of the overall uptime of the containers, in one particular setup, in the [low minutes](#); see also update [here](#).

Network security

Out of the box, Docker has **inter-container communication** enabled (meaning the default is `--icc=true`); this means containers on a host can communicate with each other without any restrictions, which can potentially lead to denial-of-service attacks. Further, Docker controls the communication **between containers and the wider world** through the `--ip_forward` and `--iptables` flags. You should study the defaults of these flags and loop in your security team concerning company policies and how to reflect them in the Docker daemon setup. Also, check out the **Docker security analysis** Boyd Hemphill of Stack-Engine carried out.

Another network security aspect is that of on-the-wire encryption, which usually means TLS/SSL as per **RFC 5246**. Note, however, that at the time of this writing this aspect is rarely addressed; indeed, only two systems, which we will discuss in greater detail in the next chapter, provide this out of the box: Weave uses **NaCl** and OpenVPN has a TLS-based setup. As I've learned from Docker's security lead, Diogo Mónica, on-the-wire encryption will likely be available **after v1.9**.

Last but not least, check out Adrian Mouat's **Using Docker**, which covers the network security aspect in great detail.



TIP

Automated Docker Security Checks

In order to automatically check against common security best practices around deploying Docker containers in production, I strongly recommend running **The Docker Bench for Security**.

Now that we have a basic understanding of the solution space for a simple setup, let's have a look at a likely more interesting case: multi-host networking with Docker.

Docker Multihost Networking

As long as you're using Docker on a single host, the techniques introduced in the previous chapter are really all you need. However, if the capacity of a host is not sufficient to sustain the workload, you will either need to buy a bigger box (scale up) or add more machines of the same type (scale out).

In the latter case, you end up with a network of machines (i.e., a cluster). Now, a number of questions arise: How do containers talk to each other on different hosts? How do you control communication between containers and between the outside world? How do you keep state, such as IP address assignments, consistent in a cluster? What are the integration points with the existing networking infrastructure? What about security policies?

In order to address these questions, we will review technologies for Docker multihost networking in this chapter.¹

¹ For some background on this topic, read [DOCKER-8951](#), which contains a detailed discussion of the problem statement; also, the Docker docs now has a dedicated section on [multihost networking](#).

 TIP

For the options discussed in this chapter, please do remember that Docker subscribes to a “batteries included but replaceable” paradigm. By that I mean that there will always be a default functionality (like networking or service discovery) that you can exchange with alternatives.

Overlay

In March 2015, Docker, Inc., **acquired** the software-defined networking (SDN) startup SocketPlane and rebranded it as **Docker Overlay Driver**; this is the upcoming default for multihost networking (in Docker 1.9 and above). The Overlay Driver extends the normal bridge mode by a **peer-to-peer** communication and uses a plugable key-value store backend to distribute cluster state, supporting Consul, etcd, and ZooKeeper.

Flannel

CoreOS **flannel** is a virtual network that gives a subnet to each host for use with container runtimes. Each container (or pod, in the case of Kubernetes) has a unique, routable IP inside the cluster and it supports a range of backends such as VXLAN, AWS VPC, and the default layer 2 UDP overlay network. The advantage of flannel is that it reduces the complexity of doing port mapping. For example, Red Hat’s **Project Atomic** uses **flannel**.

Weave

Weaveworks **Weave** creates a virtual network that connects Docker containers deployed across multiple hosts. Applications use the network just as if the containers were all plugged into the same network switch, with no need to configure port mappings and links. Services provided by application containers on the Weave network can be made accessible to the outside world, regardless of where those containers are running. Similarly, existing internal systems can be exposed to application containers irrespective of their location. Weave can traverse firewalls and operate in partially connected networks. Traffic can be encrypted, allowing hosts to be connected across an untrusted network. You can learn more about Weave’s discovery features in Alvaro Saurin’s “**Automating Weave Deployment on Docker Hosts with Weave Discovery**”.

Project Calico

Metaswitch's **Project Calico** uses standard IP routing—to be precise, the venerable Border Gateway Protocol (BGP), as defined in [RFC 1105](#)—and networking tools to provide a layer 3 solution. In contrast, most other networking solutions, including Weave, build an overlay network by encapsulating layer 2 traffic into a higher layer. The primary operating mode requires no encapsulation and is designed for datacenters where the organization has control over the physical network fabric.

Open vSwitch

Open vSwitch is a multilayer virtual switch designed to enable network automation through programmatic extension while supporting standard management interfaces and protocols, such as NetFlow, IPFIX, LACP, and 802.1ag. In addition, it is designed to support distribution across multiple physical servers, quite similar to VMware's vNetwork distributed vSwitch or Cisco's Nexus 1000V.

Pipework

Pipework was created by Jérôme Petazzoni, a rather well-known Docker engineer, and promises to be “software-defined networking for Linux containers.” It lets you connect containers in arbitrarily complex scenarios using cgroups and namespace and works with LXC containers as well as with Docker. Given the Docker, Inc., acquisition of SocketPlane and the introduction of the Overlay Driver, cf. [“Overlay” on page 16](#), we will have to see how, if at all, these activities will consolidate.

OpenVPN

OpenVPN, another OSS project that has a commercial offering, allows you to create virtual private networks (VPNs) using TLS. These VPNs can also be used to securely connect containers to each other over the public Internet. If you want to try out a Docker-based setup, I suggest taking a look at DigitalOcean's great walk-through tutorial [“How To Run OpenVPN in a Docker Container on Ubuntu 14.04”](#).

Future Docker Networking

In the recently released Docker [version 1.9](#), a new `docker network` command has been introduced. With this, containers can then also dynamically connect to other networks, with each network potentially backed by a different network driver. The default multihost network driver is Overlay (discussed earlier in [“Overlay” on page 16](#)).

In order to gather more hands-on experience, I suggest checking out the following blog posts:

- Aleksandr Tarasov’s [“Splendors and Miseries of Docker Network”](#)
- Project Calico’s [“Docker libnetwork Is Almost Here, and Calico Is Ready!”](#)
- Weave Works’ [“Life and Docker Networking – One Year On”](#)

Wrapping It Up

In this chapter, we reviewed multihost networking options, and we close out with a brief discussion on other aspects you should be aware of in this context:

IPVLAN

The Linux kernel [version 3.19](#) introduced an *IP-per-container feature*. This assigns each container on a host a unique and (world-wide) routable IP address. Effectively, IPVLAN takes a single network interface and creates multiple virtual network interfaces with different MAC addresses assigned to them. This relatively [recent feature](#), which was contributed by Mahesh Banderwar of Google, is conceptually similar to the [macvlan driver](#), but is more flexible because it’s operating both on L2 and L3. If your Linux [distro](#) already has a kernel > 3.19, you’re in luck; otherwise, you cannot yet benefit from this feature.

IP address management (IPAM)

One of the bigger challenges concerning multihost networking is the **allocation of IP addresses** to containers in a cluster.²

Orchestration tool compatibility

Most if not all of the multihost networking solutions discussed in this chapter are effectively co-processes wrapping the Docker API and configuring the networking for you. This means that before you select one, you should make sure to check compatibility issues with the container orchestration tool you're using. More on this topic in **Chapter 5**.

IPv4 versus IPv6

To date, most Docker deployments use the standard IPv4, but IPv6 is witnessing some uptake. Docker supports IPv6 **since v1.5** (released in February 2015). The ever-growing address shortage in IPv4 land might encourage more IPv6 deployments down the line, also getting rid of NATs, however it is unclear when exactly the tipping point will be reached here.

At this point in time, you should have a good understanding of the low-level and Docker networking options and challenges. We now move on to the next layer in the stack: service discovery.

² As for some background on IPAM, check out the “**Mesos Networking**” talk from MesosCon 2015 in Seattle; it contains an excellent discussion of the problem statement and potential approaches to solving it.

Containers and Service Discovery

The primary challenge arising from adopting the cattle approach to managing infrastructure (introduced in [Chapter 1](#)) is service discovery. Service discovery and container scheduling are really two sides of the same coin. If you subscribe to the cattle approach to managing infrastructure, you treat all of your machines equally and you do not manually allocate certain machines for certain applications; instead, you leave it up to a piece of software (the scheduler) to manage the life cycle of the containers.

Then the question is: How do you determine on which host your container ended up being scheduled? Exactly! This is called service discovery, and we will discuss the other side of the coin, container orchestration, in [Chapter 5](#) in greater detail.

The Challenge

Service discovery has been around for a while, considered to be part of zeroconf (see the sidebar that follows).

zeroconf

The idea behind **zeroconf** is to automatically create and manage a computer network by automatically assigning network addresses, automatically distributing and resolving hostnames, and automatically managing network services.

In the context of Docker containers, the challenge boils down to reliably maintaining a mapping between a running container and its location. By location, I mean its IP address (or the address of the host from which it has been launched) and potentially on which port it is reachable. This mapping has to be done in a timely manner and accurately across relaunches of the container throughout the cluster. Two distinct operations must be supported by a container service discovery solution:

Register

Establishes the container -> location mapping. Because only the container scheduler knows where containers “live,” we can consider it to be the absolute source of truth concerning a container’s location.

Lookup

Enables other services or applications to look up the mapping we stored during registration. Interesting properties include the freshness of the information and the latency of a query (average, p50, p90, etc.).

Let’s take a look at a few slightly orthogonal considerations for the selection process:

- Rather than simply sending a requestor in a certain direction, how about excluding unhealthy hosts or hanging containers from the lookup path? You’ve guessed it, it’s the strongly related topic of load balancing, and because it is of such importance we’ll discuss options in the last section of this chapter.
- Some argue it’s an implementation detail, others say the position in the CAP triangle (see “[The CAP Theorem and Beyond](#)” on [page 23](#)) matters: the choice of strong consistency versus high availability in the context of the service discovery tool might influence your decision. Be at least aware of it.
- Your choice might also be impacted by scalability considerations. Sure, if you only have a handful of nodes under management then all of the thereafter discussed solutions are a fit. If your cluster, however, is in the high 100s or even 1,000s of nodes, then you will want to make sure you did some proper load testing before you commit to one particular technology.

The CAP Theorem and Beyond

In 1998, Eric Brewer introduced the **CAP theorem** in the context of distributed systems. *CAP* stands for *consistency-availability-partition tolerance*, defined as follows:

Consistency

All nodes in a distributed system see the same data at the same time.

Availability

A guarantee that every request receives a response about whether it succeeded or failed.

Partition tolerance

The distributed system continues to operate despite arbitrary partitioning due to network failures.

The CAP theorem has since been the topic of many discussions among distributed systems practitioners. While in practice you still hear people arguing mainly about strong consistency versus eventual consistent systems, I suggest reading Martin Kleppmann's excellent paper, "[A Critique of the CAP Theorem](#)". This paper proposes a different, more pragmatic way to think about CAP in general and consistency in particular.

If you want to learn more about requirements and fundamental challenges in this space, read Jeff Lindsay's "[Understanding Modern Service Discovery with Docker](#)" and check out what [Simon Eskildsen of Shopify](#) shared on this topic at a recent DockerCon.

Technologies

This section briefly introduces each technology, listing pros and cons and pointing to further discussions on the Web (if you want to gain hands-on knowledge with these technologies, you should check out Adrian Mouat's excellent book *Using Docker*).

ZooKeeper

Apache **ZooKeeper** is an ASF top-level project and a JVM-based, centralized tool for configuration management,¹ providing comparable functionality to what Google's **Chubby** brings to the table. ZooKeeper (ZK) organizes its payload data somewhat like a filesystem, in a hierarchy of so-called **znodes**. In a cluster, a leader is **elected** and clients can connect to any of the servers to retrieve data. You want $2n+1$ nodes in a ZK cluster. The most often found configurations in the wild are three, five, or seven nodes. Beyond that, you'll experience diminishing returns concerning the fault tolerance-throughput tradeoff.

ZooKeeper is a battle-proven, mature, and scalable solution, but has some operational downsides. Some people consider the installation and the management of a ZK cluster as a not-so-enjoyable experience. Most ZK issues I've seen come from the fact that certain services (Apache Storm comes to mind) misuse it. They either put too much data into the **znodes**, or even worse, they have an **unhealthy read-write ratio**, essentially writing too fast. If you plan to use ZK, at least consider using higher-level interfaces, such as **Apache Curator**, which is a wrapper library around ZK, implementing a number of recipes, as well as **Netflix's Exhibitor** for managing and monitoring a ZK cluster.

Looking at **Figure 4-1**, you see two components: the R/W (which stands for registration watcher, a piece of software you need to provide yourself), and NGINX, controlled by R/W. Whenever a container is scheduled on a node, it registers with ZK, using a **znode** with a path like `/$nodeID/$containerID` and the IP address as its payload. The R/W watches changes on those **znodes** and configures NGINX accordingly. This setup also works for HAProxy and other load balancers.

¹ ZooKeeper was originally developed at Yahoo! in order to get its ever-growing zoo of software tools, including Hadoop, under control.

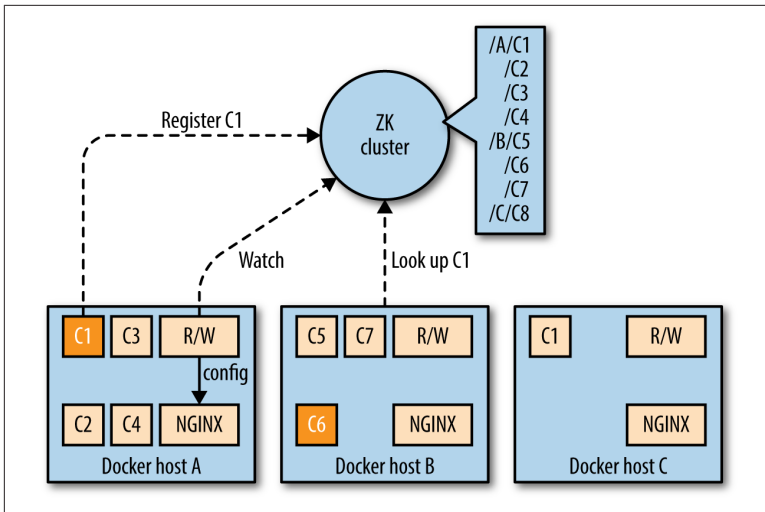

Figure 4-1. Example service discovery with ZooKeeper

etcd

Written in the Go language, **etcd** is a product of the CoreOS team.² It is a lightweight, distributed key-value store that uses the **Raft algorithm** for consensus (leader–follower model, with leader election) and employing a replicated log across the cluster to distribute the writes a leader receives to its followers. In a sense, etcd is conceptually quite similar to ZK. While the payload can be arbitrary, etcd’s HTTP API is JSON-based³ and as with ZK, you can watch for changes in the values etcd makes available to the cluster. A very useful feature of etcd is that of TTLs on keys, which is a great building block for service discovery. In the same manner as ZK, you want $2n+1$ nodes in an etcd cluster, for the same reasons.

The security model etcd provides allows on-the-wire encryption through TLS/SSL as well as client cert authentication, both for between clients and the cluster as well as between the etcd nodes.

In **Figure 4-2**, you can see that the etcd service discovery setup is quite similar to the ZK setup. The main difference is the usage of **confd**, which configures NGINX, rather than having you write your

² Did you know that etcd comes from /etc distributed? What a name!

³ That is, in contrast to ZK, all you need to interact with etcd is `curl` or the like.

own script. As with ZK, this setup also works for HAProxy and other load balancers.

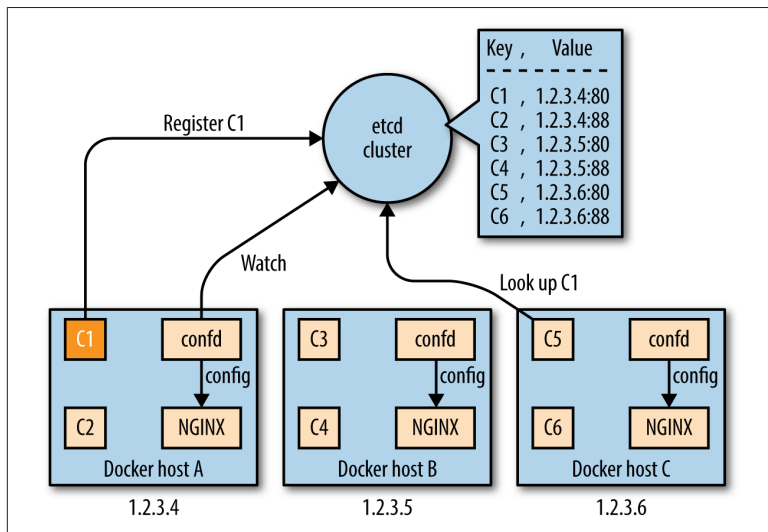

Figure 4-2. Example service discovery with etcd

Consul

Consul, a HashiCorp product also written in the Go language, exposes functionality for service registration, discovery, and health checking in an opinionated way. Services can be queried using either the HTTP API or through DNS. Consul supports multi-datacenter deployments.

One of Consul's features is a distributed key-value store, akin to etcd. It also uses the Raft consensus algorithm (and again the same observations concerning $2n+1$ nodes as with ZK and etcd apply), but the deployment is different. Consul has the concept of agents, which can be run in either of the two available modes: as a server (provides key-value store and DNS), or as a client (registers services and runs health checks) and with the membership and node discovery implemented by **serf**.

With Consul, you have essentially four options to implement service discovery (from most desirable to least desirable):

- Use a **service definition config** file, interpreted by the Consul agent.

- Use tools like traefik, which have a [Consul backend](#).
- Write your own side-kick process that registers the service through the [HTTP API](#).
- Bake the registration into the service itself through leveraging the HTTP API.

Want to learn more about Consul for service discovery? Check out these two great blog posts: “[Consul Service Discovery with Docker](#)” and “[Docker DNS & Service Discovery with Consul and Registrator](#)”.

Pure-Play DNS-Based Solutions

DNS has been a robust and battle-proven workhorse on the Internet for many decades. The eventual consistency of the DNS system, the fact that certain clients aggressively cache DNS lookups,⁴ and also the reliance on SRV records make this option something you will want to use when you know exactly that it is the right one.

I’ve titled this section “Pure-Play DNS-Based Solutions” because Consul technically also has a DNS server, but this is only one option for how you can use it to do service discovery. Here are some popular and widely used pure-play DNS-based service discovery solutions:

Mesos-DNS

This solution is specific for service discovery in Apache Mesos. Written in Go, [Mesos-DNS](#) polls the active Mesos Master process for any running tasks and exposes the IP:PORT info via DNS as well as through an HTTP API. For DNS requests for other hostnames or services, Mesos-DNS can either use an external nameserver or leverage your existing DNS server to forward only the requests for Mesos tasks to Mesos-DNS.

SkyDNS

Using etcd, you can announce your services to [SkyDNS](#), which stores service definitions into etcd and updates its DNS records. Your client application issues DNS queries to discover the services. Thus, functionality-wise it is quite similar to Consul, without the health checks.

⁴ [Java](#), I’m looking at you.

WeaveDNS

WeaveDNS was introduced in Weave 0.9 as a simple solution to service discovery on the Weave network, allowing containers to find other containers' IP addresses by their hostnames. In Weave 1.1, a so-called **Gossip DNS** was introduced, making lookups faster through a cache as well as timeout functionality. In the new implementation, registrations are broadcast to all participating instances, which subsequently hold all entries in memory and handle lookups locally.

Airbnb's SmartStack and Netflix's Eureka

In this section, we'll take a look at two bespoke systems that were developed to address specific requirements. This doesn't mean you can't or shouldn't use them, just that you should be aware of this heritage.

Airbnb's **SmartStack** is an automated service discovery and registration framework, transparently handling creation, deletion, failure, and maintenance work. SmartStack uses two separate services that run on the same host as your container: Nerve (writing into ZK) for service registration, and Synapse (dynamically configuring HAProxy) for lookup. It is a well-established solution for non-containerized environments and time will tell if it will also be as useful with Docker.

Netflix's **Eureka** is different. This comes mainly from the fact that it was born in the AWS environment (where all of Netflix runs). Eureka is a REST-based service used for locating services for the purpose of load balancing and failover of middle-tier servers and also comes with a Java-based client component, which makes interactions with the service straightforward. This client also has a built-in load balancer that does basic round-robin load balancing. At Netflix, Eureka is used for red/black deployments, for Cassandra and memcached deployments, and for carrying application-specific metadata about services.

Participating nodes in a Eureka cluster replicate their service registries between each other asynchronously; in contrast to ZK, etcd, or Consul, Eureka favors service availability over strong consistency, leaving it up to the client to deal with the stale reads, but with the upside of being more resilient in case of networking partitions. And you know: The network is reliable. **Not.**

Load Balancing

One aspect of service discovery—sometimes considered orthogonal, but really an integral part of it—is load balancing: it allows you to spread the load (service inbound requests) across a number of containers. In the context of containers and microservices, load balancing achieves a couple of things at the same time:

- Allows throughput to be maximized and response time to be minimized
- Can avoid hotspotting (i.e., overloading a single container)
- Can help with overly aggressive DNS caching such as found with [Java](#)

The following list outlines some popular load balancing options with Docker:

NGINX

A popular open source load balancer and web server. NGINX is known for its high performance, stability, simple configuration, and low resource consumption. NGINX integrates well with the service discovery platforms presented in this chapter, as well as with many other open source projects.

HAProxy

While not very feature-rich, it is a very stable, mature, and battle-proven workhorse. Often used in conjunction with NGINX, HAProxy is reliable and integrations with pretty much everything under the sun exist. Use, for example, the [tutum-cloud/haproxy](#) Docker images; because Docker, Inc., acquired Tutum recently, you can expect this image will soon be part of the native Docker tooling.

Bamboo

A daemon that automatically configures HAProxy instances, deployed on Apache Mesos and Marathon; see also this [p24e.io guide](#) for a concrete recipe.

Kube-Proxy

Runs on each node of a Kubernetes cluster and reflects services as defined in the Kubernetes API. It supports simple TCP/UDP forwarding and round-robin and Docker-links-based service IP:PORT mapping.

vulcand

A HTTP reverse proxy for HTTP API management and microservices, inspired by [Hystrix](#).

Magnetic.io's vamp-router

Inspired by Bamboo and Consul-HAProxy, it supports updates of the config through REST or Zookeeper, routes and filters for canary releasing and A/B-testing, as well as provides for stats and ACLs.

moxy

A HTTP reverse proxy and load balancer that automatically configures itself for microservices deployed on Apache Mesos and Marathon.

HAProxy-SRV

A templating solution that can flexibly reconfigure HAProxy based on the regular polling of the service data from DNS (e.g., SkyDNS or Mesos-DNS) using SRV records.

Marathon's servicrouter.py

The servicrouter is a simple script that gets app configurations from Marathon and updates HAProxy; see also this [p24e.io recipe](#).

traefik

The new kid on the block. Only very recently released but already sporting 1,000+ stars on GitHub, Emile Vauge (traefik's lead developer) must be doing something right. I like it because it's like HAProxy, but comes with a bunch of backends such as Marathon and Consul out of the box.

If you want to learn more about load balancing, check out this [Mesos meetup video](#) as well as this talk from [nginx.conf 2014](#) on load balancing with NGINX+Consul.

Wrapping It Up

To close out this chapter, I've put together a table that provides you with an overview of the service discovery solutions we've discussed. I explicitly do not aim at declaring a winner, because I believe it very much depends on your use case and requirements. So, take the following table as a quick orientation and summary but not as a shoot-out:

Name	Consistency	Language	Registration	Lookup
ZooKeeper	Strong	Java	Client	Bespoke clients
etcd	Strong	Go	Sidekick+client	HTTP API
Consul	Strong	Go	Automatic and through traefik (Consul backend)	DNS + HTTP/JSON API
Mesos-DNS	Strong	Go	Automatic and through traefik (Marathon backend)	DNS + HTTP/JSON API
SkyDNS	Strong	Go	Client registration	DNS
WeaveDNS	Strong	Go	Auto	DNS
SmartStack	Strong	Java	Client registration	Automatic through HAProxy config
Eureka	Eventual	Java	Client registration	Bespoke clients

As a final note: the area of service discovery is constantly in flux and new tooling is available almost on a weekly basis. For example, Uber only recently open sourced its internal solution, **Hyperbahn**, an overlay network of routers designed to support the **TChannel RPC protocol**. Because container service discovery is overall a moving target, you are well advised to reevaluate the initial choices on an ongoing basis, at least until some consolidation has taken place.

Containers and Orchestration

As mentioned in the previous chapter, with the cattle approach to managing infrastructure, you don't manually allocate certain machines for certain applications—instead, you leave it up to a scheduler to manage the life cycle of the containers. While scheduling is an important activity, it is actually just one part of a broader concept: orchestration.

In [Figure 5-1](#), you can see that orchestration includes things such as health checks, organizational primitives (e.g., labels in Kubernetes or groups in Marathon), autoscaling, upgrade/rollback strategies, as well as service discovery. Sometimes considered part of orchestration but outside of the scope of this book is the topic of base provisioning, such as setting up a Mesos Agent or Kubernetes Kubelet.

Service discovery and scheduling are really two sides of the same coin. The entity that decides where in a cluster a certain container is placed is called a scheduler. It supplies other systems with an up-to-date mapping containers -> locations, which then can be used to expose this information in various ways, be it in distributed key-value stores such as etcd or through DNS as the case with, for example, Mesos-DNS.

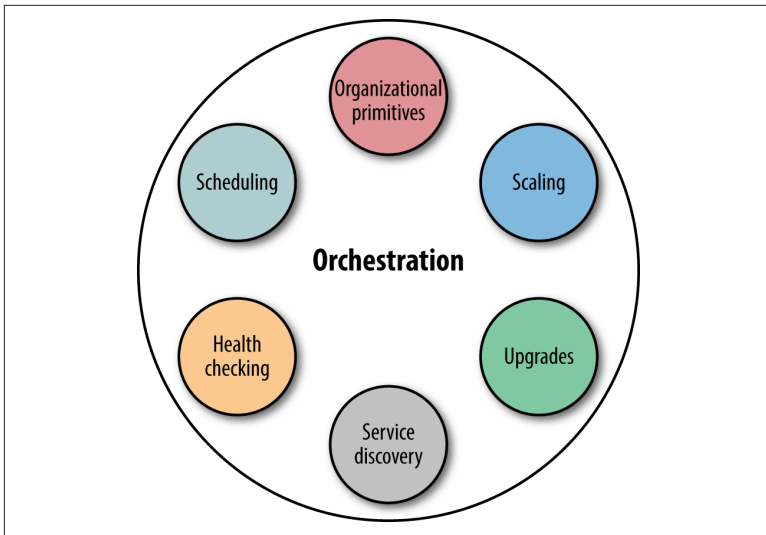

Figure 5-1. Orchestration and its constituents

In this chapter, we will discuss service discovery and networking from the point of view of the container orchestration solution. The motivation behind this is simple: assume that you've decided to go with a certain platform, say, Kubernetes. Then, your primary concern is how service discovery and networking is handled in the context of this platform.

NOTE

In the following, I've made the choice to discuss container orchestration systems that fulfill two requirements: they are open source and they have a considerable community up-take (or in Nomad's case, this is expected to happen, relatively soon).

There are several other solutions out there you could have a look at, including Facebook's **Bistro** or hosted solutions such as Amazon EC2 Container Service **ECS**.

And, should you want to more fully explore the topic of distributed system scheduling, I suggest reading Google's research papers on **Borg** and **Omega**.

Before we dive into container orchestration systems, let's step back and review what the scheduler—which is the core component of orchestration—actually does in the context of Docker.

What Does a Scheduler Actually Do?

A distributed systems scheduler takes an application by request of a user and places it on one or more of the available machines. For example, a user might request to have 100 instances (or replicas, in the case of Kubernetes) of the app running.

In the case of Docker, this means that (a) the respective Docker image must exist on a host, and (b) the scheduler tells the local Docker daemon to launch a container based on it.

In [Figure 5-2](#), you can see that the user requested three instances of the app running in the cluster. The scheduler decides the actual placement based on its knowledge of the state of the cluster, primarily the utilization of the machines, resources necessary to successfully launch the app, and constraints such as *launch this app only on a machine that is SSD-backed*. Further, quality of service might be taken into account for the placement decision.

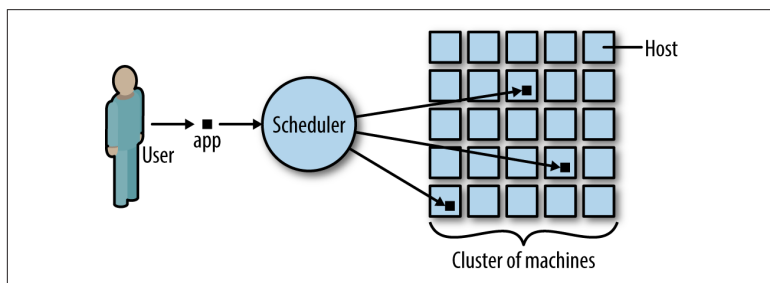

Figure 5-2. Distributed systems scheduler in action

Learn more about this topic via [Cluster Management at Google](#) by John Wilkes.



Beware of the semantics of constraints that you can place on scheduling containers. For example, I once gave a Marathon demo that wouldn't work as planned because I screwed up concerning the **placement constraints**: I used a combination of unique hostname and a certain role and it wouldn't scale, because there was only one node with the specified role in the cluster. The same thing can happen with Kubernetes labels.

Vanilla Docker and Docker Swarm

Out of the box, Docker provides a basic service discovery mechanism: Docker links. By default, all containers can communicate directly with each other if they know each other's IP addresses. Linking allows a user to let any container discover both the IP address and exposed ports of other Docker containers on the same host. In order to accomplish this, Docker provides the `--link` flag, a convenient command-line option that does this **automatically**.

But hard-wiring of links between containers is neither fun nor scalable. In fact, it's so bad that, going forward, this feature will be deprecated.¹

Let's have a look at a better solution (if you nevertheless want to or need to use links): the **ambassador pattern**.

Ambassadors

The idea behind this pattern, shown in **Figure 5-3**, is to use a proxy container that stands in for the real container and forwards traffic to the real thing.² What it buys you is the following: the ambassador pattern allows you to have a different network architecture in the development phase and in production. The network ops can rewire the application at runtime, without changing the application's code.

In a nutshell, the downside of ambassadors is that they don't scale well. The ambassador pattern can be used in small-scale, manual deployments but should be avoided when employing an actual container orchestration tool such as Kubernetes or Apache Mesos.

1 See the last section of the "**Understand Docker Container Networks**" page.

2 Why it's called *ambassador* when it clearly is a proxy at work here is beyond me.

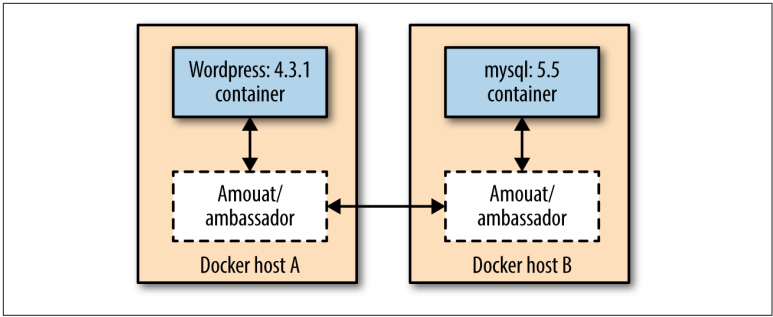

Figure 5-3. Fully configured Docker linking using the Ambassador pattern

NOTE If you want to know how to actually implement the ambassador pattern in Docker, I'll again refer you to Adrian Mouat's awesome book *Using Docker*. In fact, in [Figure 5-3](#), I'm using his `amouat/ambassador` Docker image.

Docker Swarm

Beyond the static linking of containers, Docker has a native clustering tool called **Docker Swarm**. Docker Swarm **builds upon the Docker API³** and works as follows: there's one Swarm manager, responsible for the **scheduling** and one each host an agent runs, which takes care of the local resource management ([Figure 5-4](#)).

The interesting thing about Swarm is that the scheduler is plug-able, so you can, for example, use Apache Mesos rather than one of the included schedulers. At the time of writing this book, **Swarm turned 1.0** and subsequently it was awarded General Availability status; new features such as **high availability** are being worked on an ongoing basis.

³ Essentially, this means that you can simply keep using `docker run` commands and the deployment of your containers in a cluster happens automatically.

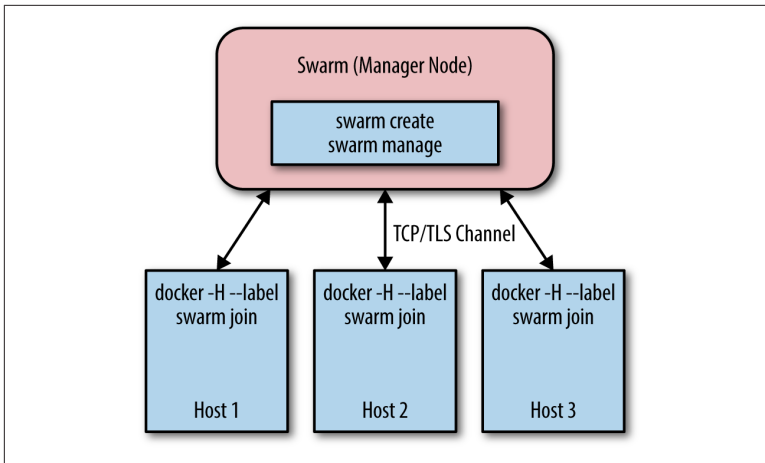

Figure 5-4. Docker Swarm architecture, based on *Swarm - A Docker Clustering System* presentation

Networking

We discussed Docker single-host and multihost networking earlier in this book, so I'll simply point you to Chapters 2 and 3 to read up on it.

Service Discovery

Docker Swarm supports **different backends**: etcd, Consul, and Zookeeper. You can also use a **static file** to capture your cluster state with Swarm and only recently a DNS-based service discovery tool for Swarm, called **wagl**, has been introduced.

If you want to dive deeper into Docker Swarm, check out Rajdeep Dua's "**Docker Swarm**" [slide deck](#).

Kubernetes

Kubernetes (see Figure 5-5) is an opinionated open source framework for elastically managing containerized applications. In a nutshell, it captures Google's lessons learned from running containerized workloads for more than 10 years, which we will briefly discuss here. Further, you almost always have the option to swap out the default implementations with some open source or closed source alternative, be it DNS or monitoring.

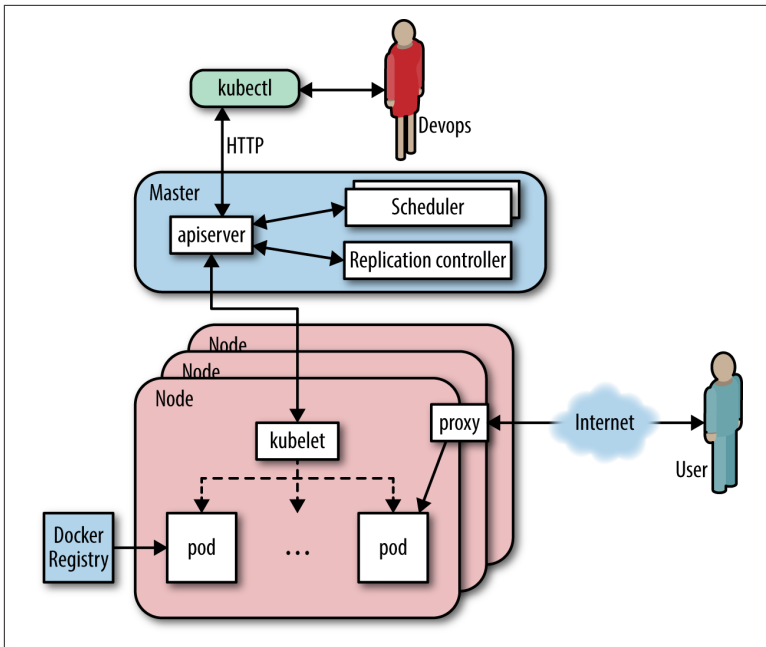

Figure 5-5. An overview of the Kubernetes architecture

This discussion assumes you're somewhat familiar with Kubernetes and its terminology. Should you not be familiar with Kubernetes, I suggest checking out Kelsey Hightower's wonderful book *Kubernetes Up and Running*.

The unit of scheduling in Kubernetes is a pod. Essentially, this is a tightly coupled set of containers that is always collocated. The number of running instances of a pod (called replicas) can be declaratively stated and enforced through Replication Controllers. The logical organization of pods and services happens through labels.

Per Kubernetes node, an agent called Kubelet runs, which is responsible for controlling the Docker daemon, informing the Master about the node status and setting up node resources. The Master exposes an API (for an example web UI, see Figure 5-6), collects and stores the current state of the cluster in etcd, and schedules pods onto nodes.

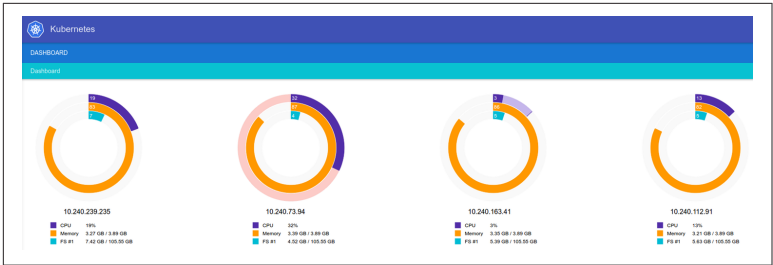

Figure 5-6. The Kubernetes Web UI

Networking

In Kubernetes, each pod has a routable IP, allowing pods to communicate across cluster nodes without NAT. Containers in a pod share a port namespace and have the same notion of localhost, so there's no need for port brokering. These are fundamental requirements of Kubernetes, which are satisfied by using a network overlay.

Within a pod there exists a so-called *infrastructure container*, which is the first container that the Kubelet instantiates and it acquires the pod's IP and sets up the network namespace. All the other containers in the pod then join the infra container's network and IPC namespace. The infra container has network bridge mode enabled (see "Bridge Mode Networking" on page 9) and all the other containers in the pod share its namespace via container mode (covered in "Container Mode Networking" on page 11). The initial process that runs in the infra container does effectively nothing,⁴ as its sole purpose is to act as the home for the namespaces. Recent work around port forwarding can result in additional processes being launched in the infra container. If the infrastructure container dies, the Kubelet kills all the containers in the pod and then starts the process over.

Further, Kubernetes **Namespaces** enable all sorts of control points; one example in the networking space is Project Calico's usage of namespaces to **enforce a coarse-grained network policy**.

Service Discovery

In the Kubernetes world, there's a canonical abstraction for service discovery and this is (unsurprisingly) the **service primitive**. While

⁴ See [pause.go](https://github.com/kubernetes/kubernetes/blob/master/pkg/kubelet/kubelet.go#L1000) for details; basically blocks until it receives a SIGTERM.

Pods may come and go as they fail (or the host they're running on fails), services are long-lived things: they deliver cluster-wide service discovery as well as some level of load balancing. They provide a stable IP address and a persistent name, compensating for the short-livedness of all equally labelled pods. Effectively, Kubernetes supports two discovery mechanisms: through environment variables (limited to a certain node) and DNS (cluster-wide).

Apache Mesos

Apache Mesos (Figure 5-7) is a general-purpose cluster resource manager that abstracts the resources of a cluster (CPU, RAM, etc.) in a way that the cluster appears like one giant computer to you, as a developer.

In a sense, Mesos acts like the kernel of a distributed operating system. It is hence never used standalone, but always together with so-called *frameworks*, such as Marathon (for long-running stuff like a web server), Chronos (for batch jobs) or Big Data frameworks like Apache Spark or Apache Cassandra.

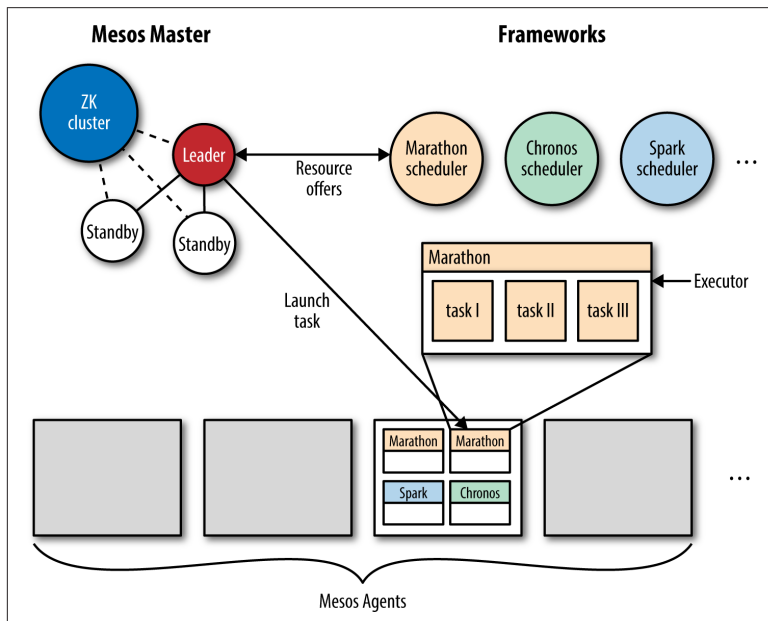

Figure 5-7. Apache Mesos architecture at a glance

Mesos supports both containerized workloads, that is, running Docker containers as well as plain executables (including bash scripts, Python scripts, JVM-based apps, or simply a good old Linux binary format) for both stateless and stateful services.⁵

In the following, I'm assuming you're familiar with Mesos and its terminology. If you're new to Mesos, I suggest checking out David Greenberg's wonderful book *Building Applications on Mesos*, a gentle introduction into this topic, particularly useful for distributed application developers.

In [Figure 5-8](#), you can see the Marathon UI in action, allowing you to launch and manage long-running services and applications on top of Apache Mesos.

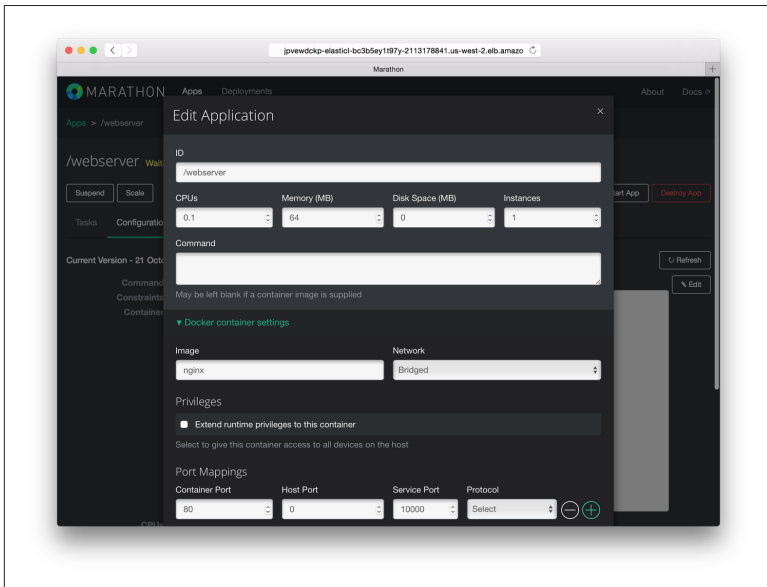

Figure 5-8. The Apache Mesos framework Marathon, launching an NGINX Docker image

⁵ It should be noted that concerning stateful services such as databases (MySQL, Cassandra, etc.) or distributed filesystems (HDFS, Quobyte, etc.), we're still in the early days in terms of support, as most of the persistence primitives landed only very recently in Mesos; see Felix Hupfeld and Jörg Schad's presentation "[Apache Mesos Storage Now and Future](#)" for the current (end 2015) status.

Networking

The networking characteristics and capabilities mainly depend on the Mesos containerizer used:

- For the *Mesos containerizer*, there are a few **prerequisites** such as a Linux Kernel version > 3.16, and `libnl` installed. You can then build a Mesos Agent with the network isolator support enabled. At launch, you would use something like the following:

```
mesos-slave --containerizer=mesos
--isolation=network/port_mapping
--resources=ports:[31000-32000];ephemeral_ports:
[33000-35000]
```

This would configure the Mesos Agent to use non-ephemeral ports in the range from 31,000 to 32,000 and ephemeral ports in the range from 33,000 to 35,000. All containers share the host's IP and the port ranges are then spread over the containers (with a 1:1 mapping between destination port and container ID). With the network isolator, you also can define performance limitations such as bandwidth and it enables you to perform per-container monitoring of the network traffic. See the MesosCon 2015 Seattle talk “**Per Container Network Monitoring and Isolation in Mesos**” for more details on this topic.

- For the *Docker containerizer*, see **Chapter 2**.

Note that Mesos **supports IP-per-container** since version 0.23 and if you want to learn more about the current state of networking as well as upcoming developments, check out this MesosCon 2015 Seattle talk on **Mesos Networking**.

Service Discovery

While Mesos is not opinionated about service discovery, there is a Mesos-specific solution, which in praxis is often used: Mesos-DNS (see “**Pure-Play DNS-Based Solutions**” on page 27). There are, however, a multitude of emerging solutions such as traefik (see “**Wrapping It Up**” on page 30) that are integrated with Mesos and gaining traction. If you're interested in more details about **service discovery with Mesos**, our open docs site has a dedicated section on this topic.

NOTE

Because Mesos-DNS is currently the recommended default service discovery mechanism with Mesos, it's important to pay attention to how Mesos-DNS **represents the tasks**. For example, the running task you see in **Figure 5-8** would have the (logical) service name `webserver.marathon.mesos`.

Hashicorp Nomad

Nomad is a cluster scheduler by HashiCorp, the makers of Vagrant. It was **introduced in September 2015** and primarily aims at simplicity. The main idea is that Nomad is easy to install and use. Its **scheduler** design is reportedly inspired by Google's Omega, borrowing concepts such as having a global state of the cluster as well as employing an optimistic, concurrent scheduler.

Nomad has an agent-based **architecture** with a single binary that can take on different roles, supporting rolling upgrade as well as draining nodes (for re-balancing). Nomad makes use of both a consensus protocol (strongly consistent) for all state replication and scheduling and a gossip protocol used to manage the addresses of servers for automatic clustering and multiregion federation. In **Figure 5-9**, you can see a Nomad agent starting up.

```

vagrant@nomad:~$ sudo nomad agent -dev
--> Starting Nomad agent.
2015/10/19 15:56:40 [ERR] fingerprint-env.json: Error querying AWS Metadata URL, skipping
--> Nomad agent configuration:

  Atlas: disabled
  Client: true
  Log Level: DEBUG
  Region: global (DC: dc1)
  Server: true

--> Nomad agent started! Log data will stream in below:
2015/10/19 15:56:40 [INFO] seef: EventMemberJoin: nomad.global.127.0.0.1
2015/10/19 15:56:40 [INFO] nomad: starting 4 nonblocking monitor(s) for [Service health_core]
2015/10/19 15:56:40 [INFO] client: using alloc directory /tmp/nomadClient358697981
2015/10/19 15:56:40 [INFO] raft: Node at 127.0.0.1:4647 [follower] entering follower state
2015/10/19 15:56:40 [INFO] nomad: adding server nomad.global (Addr: 127.0.0.1:4647) (DC: dc1)
2015/10/19 15:56:40 [WARN] fingerprint_network: Ethtool not found, checking /sys/net speed file
2015/10/19 15:56:40 [DEBUG] client: applied fingerprints [cpu cpu host memory storage network]
2015/10/19 15:56:40 [DEBUG] client: available drivers [docker exec]
2015/10/19 15:56:40 [INFO] raft: Heartbeat timeout reached, starting election
2015/10/19 15:56:42 [INFO] raft: Node at 127.0.0.1:4647 [Candidate] entering Candidate state
2015/10/19 15:56:42 [DEBUG] raft: Votes needed: 1
2015/10/19 15:56:42 [DEBUG] raft: Vote granted, Tally: 1
2015/10/19 15:56:42 [INFO] raft: Election won, Tally: 1
2015/10/19 15:56:42 [INFO] raft: Node at 127.0.0.1:4647 [leader] entering Leader state
2015/10/19 15:56:42 [INFO] raft: Disabling EnableSingleNode (bootstrap)
2015/10/19 15:56:42 [INFO] raft: Node 127.0.0.1:4647 updates peer set (2): [127.0.0.1:4647]
2015/10/19 15:56:42 [INFO] nomad: cluster leadership acquired
2015/10/19 15:56:42 [DEBUG] client: node registration complete
2015/10/19 15:56:42 [DEBUG] client: updated allocations at index 1 (0 allocs)
2015/10/19 15:56:42 [INFO] client: allocs: Cadded 0) (removed 0) (updated 0) (ignore 0)
2015/10/19 15:56:42 [DEBUG] client: state updated to ready
--> Failed to check for updates: get https://checkpoint-api.hashicorp.com/v1/check/nomad-amd64os-linux?signature=4version=0.1.0: dial tcp: lookup checkpoint-api.hashicorp.com on 10.0.7.1:53: server not responding

```

Figure 5-9. A Nomad agent, starting up in dev mode

Jobs in Nomad are defined in a HashiCorp-proprietary format called **HCL** or in JSON, and Nomad offers both a command-line interface as well as an HTTP API to interact with the server process.

In the following, I'm assuming you're familiar with Nomad and its terminology (otherwise I suppose you wouldn't be reading this section). Should you not be familiar with Nomad, I suggest you watch “Nomad: A Distributed, Optimistically Concurrent Schedule: Armon Dadgar, HashiCorp” (a very nice introduction to Nomad by HashiCorp's CTO, Armon Dadgar) and also read the [docs](#).

Networking

Nomad comes with a couple of so-called task drivers, from general-purpose exec to Java to qemu and [Docker](#). We will focus on the latter one in the following discussion.

Nomad requires, at the time of this writing, Docker in the version 1.8.2. and uses port binding to expose services running in containers using the port space on the host's interface. It provides automatic and manual mapping schemes for Docker, binding both TCP and UDP protocols to ports used for Docker containers.

For more details on networking options, such as mapping ports and using labels, I'll point out the excellent [docs page](#).

Service Discovery

With [v0.2](#), Nomad introduced a Consul-based (see “[Consul](#)” on [page 26](#)) service discovery mechanism; see the respective [docs section](#). It includes health checks and assumes that tasks running inside Nomad also need to be able to connect to the Consul agent, which can, in the context of containers using bridge mode networking, pose a challenge.

Which One Should I Use?

The following is of course only a suggestion from where I stand. It is based on my experience and naturally I'm biased toward stuff I've been using. Your mileage may vary, and there may be other (sometimes political?) reasons why you opt for a certain technology.

From a pure scale perspective, your options look like this:

Tool	Up to 10 nodes	10 to 100 nodes	Up to 1,000 nodes	1,000s of nodes
Docker Swarm	++	+	?	?
Kubernetes	++	++	+	?
Apache Mesos	+	++	++	++
Nomad	++	?	?	?

For a **handful of nodes**, it essentially doesn't matter: choose any of the four solutions, depending on your preferences or previous experience. Do remember, however, that **managing containers at scale is hard**:

- Docker Swarm reportedly scales to 1,000 nodes, see this [HackerNews thread](#) and this [Docker blog post](#).
- Kubernetes 1.0 is known to be **scale-tested to 100s of nodes** and work is ongoing to **achieve the same scalability as Apache Mesos**.
- Apache Mesos has been simulated to be able to **manage up to 50,000 nodes**.
- No scale-out information concerning Nomad exists at the time of this writing.

From a workload perspective, your options look like this:

Tool	Non-containerized	Containerized	Batch	Long-running	Stateless	Stateful
Docker Swarm	-	++	+	++	++	+
Kubernetes	-	++	+	++	++	+
Apache Mesos	++	++	++	++	++	+
Nomad	++	++	?	++	++	?

Non-containerized means you can run anything that you can also launch from a Linux shell (e.g., bash or Python scripts, Java apps, etc.), whereas *containerized* implies you need to generate Docker images. Concerning stateful services, pretty much all of the solutions require some handholding, nowadays. If you want to learn more about choosing an orchestration tool:

- See the blog post “[Docker Clustering Tools Compared: Kubernetes vs Docker Swarm](#)”.
- Read an excellent article on O’Reilly Radar: “[Swarm v. Fleet v. Kubernetes v. Mesos](#)”.

For the sake of completeness and because it’s an awesome project, I will point out the spanking new kid on the block, [Firmament](#). Developed by folks who also contributed to Google’s Omega and Borg, this new scheduler constructs a flow network of tasks and machines and runs a minimum-cost optimization over it. What is particularly intriguing about Firmament is the fact that you can use it not only standalone but also [integrated with Kubernetes](#) and (upcoming) with Mesos.

A Day in the Life of a Container

When choosing a container orchestration solution, you should consider the entire life cycle of a container ([Figure 5-10](#)).

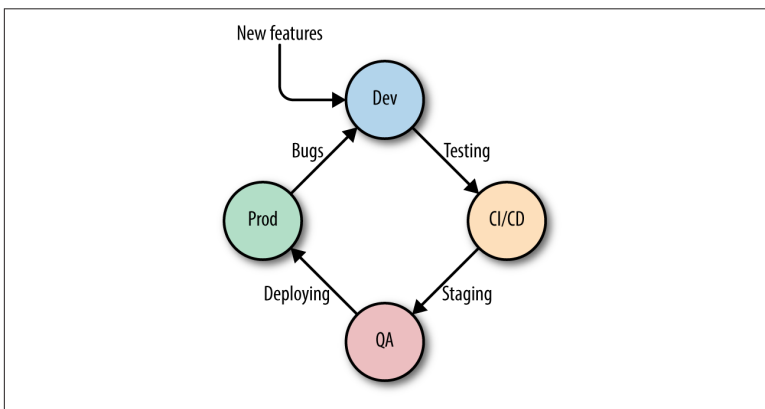

Figure 5-10. Docker container life cycle

The Docker container life cycle typically spans the following phases:

Phase I: dev

The container image (capturing the essence of your service or app) starts its life in a development environment, usually on a developer's laptop. You use feature requests and insights from running the service or application in production as inputs.

Phase II: CI/CD

Then, the container goes through a pipeline of **continuous integration and continuous delivery**, including unit testing, integration testing, and **smoke tests**.

Phase III: QA/staging

Next, you might use a QA environment (a cluster either on premises or in the cloud) and/or a staging phase.

Phase IV: prod

Finally, the container image is deployed into the production environment. When dealing with Docker, you also need to have a strategy in place for how to **distribute the images**. Don't forget to build in **canaries** as well as plan for rolling upgrades of the core system (such as Apache Mesos), potential higher-level components (like Marathon, in Mesos' case) and your services and apps.

In production, you discover bugs and may collect metrics that can be used to improve the next iteration (back to Phase I).

Most of the systems discussed here (Swarm, Kubernetes, Mesos, Nomad) offer instructions, protocols, and integration points to cover all phases. This, however, shouldn't be an excuse for not trying out the system end to end yourself before you commit to any one of these systems.

Community Matters

Another important aspect you will want to consider when selecting an orchestration system is that of the community behind and around it.⁶ Here a few indicators and metrics you can use:

⁶ Now, you may argue that this is not specific to the container orchestration domain but a general OSS issue and you'd be right. Still, I believe it is important enough to mention it, as many people are new to this area and can benefit from these insights.

- Is the governance backed by a formal entity or process, such as the Apache Software Foundation or the Linux Foundation?
- How active is the mailing list, the IRC channel, the bug/issue tracker, Git repo (number of patches or pull requests), and other community initiatives? Take a holistic view, but make sure that you actually pay attention to the activities there. Healthy (and hopefully growing) communities have high participation in at least one if not more of these areas.
- Is the orchestration tool (implicitly or not) de facto controlled by a single entity? For example, in the case of Nomad, it is clear and accepted that HashiCorp alone is in full control. How about Kubernetes? Mesos?
- Have you got several (independent) providers and support channels? For example, you can run Kubernetes or Mesos in many different environments, getting help from many (commercial or not) organizations and individuals.

With this, we've reached the end of the book. You've learned about the networking aspects of containers, as well as about service discovery options. With the content of this chapter, you're now in a position to select and implement your containerized application.

If you want to dive deeper into the topics discussed in this book, check out [Appendix A](#), which provides an organized list of resources.

References

What follows is a collection of links that either contain background info on topics covered in this book or contain advanced material, such as deep-dives or tear-downs.

Networking References

- [Docker Networking](#)
- [Concerning Containers' Connections: on Docker Networking](#)
- [Unifying Docker Container and VM Networking](#)
- [Exploring LXC Networking](#)
- [Letting Go: Docker Networking and Knowing When Enough Is Enough](#)
- [Networking in Containers and Container Clusters](#)

Service Discovery References

- [Service Discovery on p24e.io](#)
- [Understanding Modern Service Discovery with Docker](#)
- [Service Discovery in Docker Environments](#)
- [Service Discovery, Mesosphere](#)
- [Docker Service Discovery Using Etcd and HAProxy](#)
- [Service discovery with Docker: Part 1 and Part 2](#)

- [Service Discovery with Docker: Docker Links and Beyond](#)

Related and Advanced References

- [What Makes a Container Cluster?](#)
- [Fail at Scale—Reliability in the Face of Rapid Change](#)
- [Bistro: Scheduling Data-Parallel Jobs Against Live Production Systems](#)
- [Orchestrating Docker Containers with Slack](#)
- [The History of Containers](#)
- [The Comparison and Context of Unikernels and Containers](#)
- [Anatomy of a Container: Namespaces, cgroups & Some Filesystem Magic - LinuxCon](#)

About the Author

Michael Hausenblas is a developer and cloud advocate at Mesosphere. He tries to help devops and appops to build and operate distributed applications. His background is in large-scale data integration, the Hadoop stack, NoSQL datastores, REST, and IoT protocols and formats. He's experienced in standardization at W3C and IETF and contributes to open source software at the Apache Software Foundation (Mesos, Myriad, Drill, Spark) and when not hanging out at conferences, user groups, trade shows, or with customers on site, he enjoys reading and listening to a good mix of Guns N' Roses and Franz Schubert.